

SignBar®/ SignPanel®



A Complete Post, Bar & Panel System

A modular system in the true sense of the word, SignBar / SignPanel is a well engineered product which provides real permanence with a wide range of quality components, maximizing the looks you can create.

Your Source for Sign Systems

APCO

SPECIFICATION GUIDE

Product Description

Extruded Aluminium Bars in five sizes display information laterally on one or both sides. Bars are conveniently changed or rearranged by removing security caps and lifting each bar upward and out of the post pocket. Larger bars and header panels are easily created with the SignPanel feature.

Basic Configurations

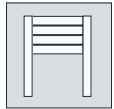

SignBar with 50mm Posts



SignBar with 100mm Posts



SignBar Wall Mount



SignBar 90 Corner



SignBar Multi-Sided Pylon

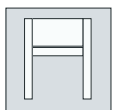

SignBar with SignPanel Header

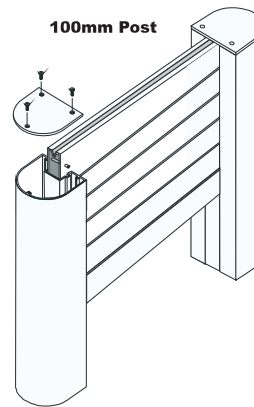

100mm Post



Wall Mount

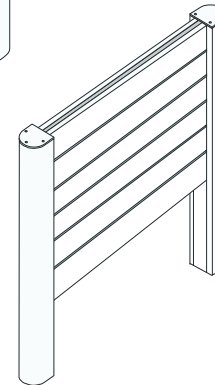

50mm Post

Product Description

A unique outer frame extrusion is clad with 1.5mm aluminium faces to create larger sizes. Panels are 28mm thick and incorporate an edge detail that interlinks with both bars and SignPanel. Panels slide within the Post or Wall Channel pocket.

Basic Configurations

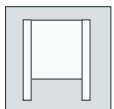

SignPanel with 50mm Posts

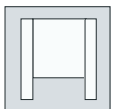

SignPanel with 100mm Posts

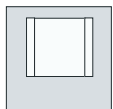

SignPanel Wall Mount

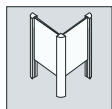

SignBar 90 Corner

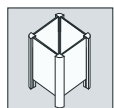

SignPanel Multi-Sided Pylon

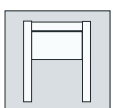

SignPanel with SignBar Header

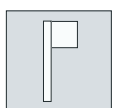

SignPanel Single Post

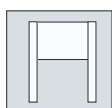

SignPanel Solid Plate Panel

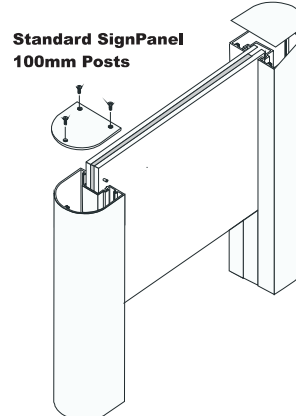

Standard SignPanel 100mm Posts

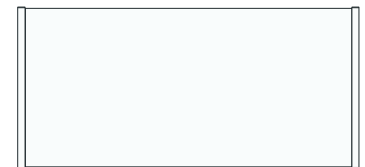

Wall Mount

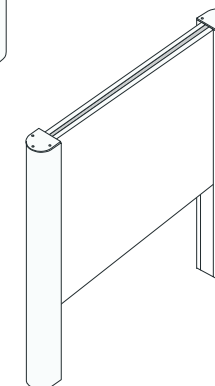

Standard SignPanel 50mm Posts

Plan View

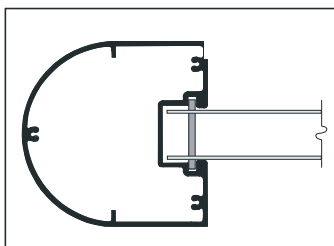

100mm Post with SignBar / Panel

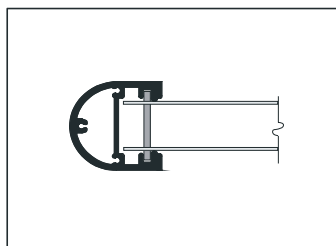

50mm Post with SignBar / Panel

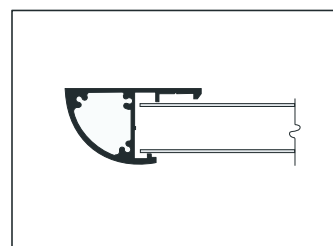

40mm Wall Channel with SignBar / Panel

Product Description

A unique filler extrusion allows for the use of virtually any 6mm thick panel material such as aluminium or acrylic etc.

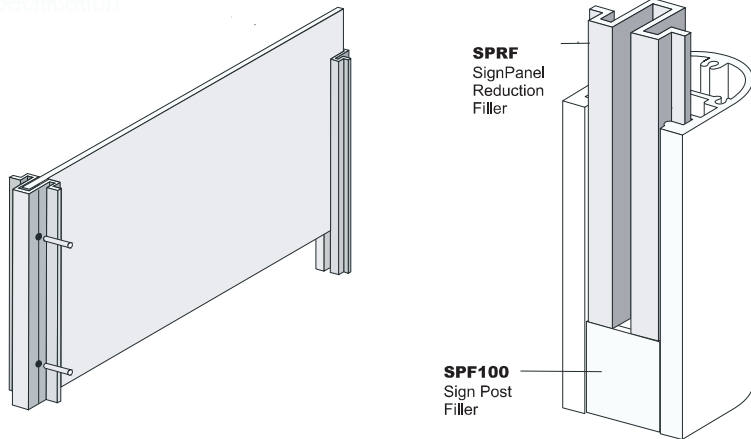

Product Description

A unique outer frame extrusion is clad with 1.5mm aluminium faces to create larger sizes. Panels are 50mm or 100mm width to create a "Flush Face" appearance when used with 50mm or 100mm posts.

Basic Configurations

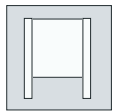

Flush Face SignPanel with 50mm Posts

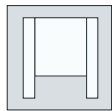

Flush Face SignPanel with 100mm Posts

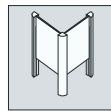

SignPanel 90° Corner

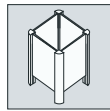

SignPanel Multi-Sided Pylon

100mm Flush Face

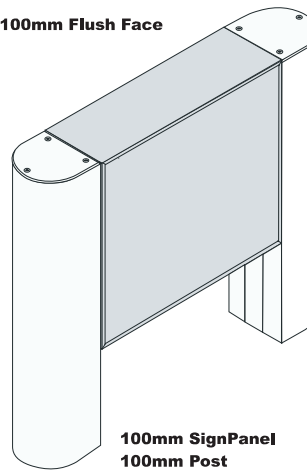

100mm SignPanel
100mm Post

50mm Flush Face

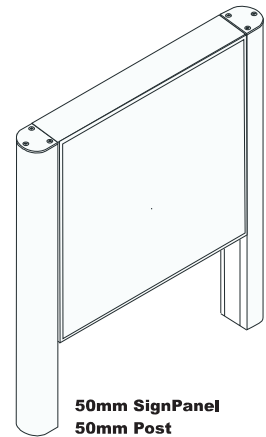

50mm SignPanel
50mm Post

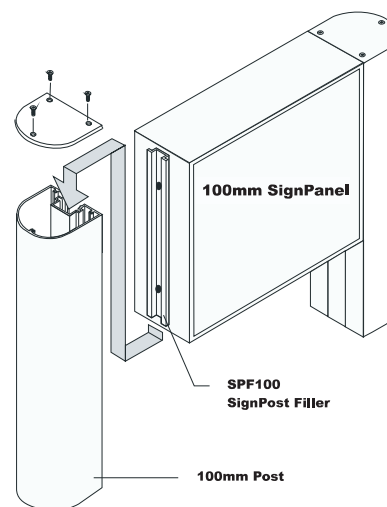

Bar Extrusions

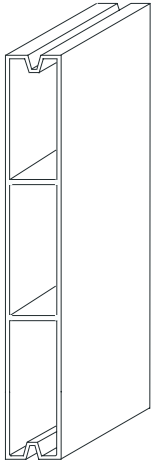

SB200
200mm

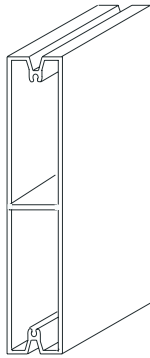

SB150
150mm

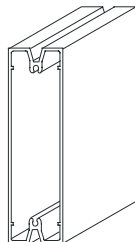

SB100
100mm

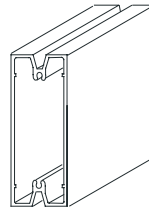

SB75
75mm

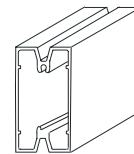

SB50
50mm

SignPanel Components

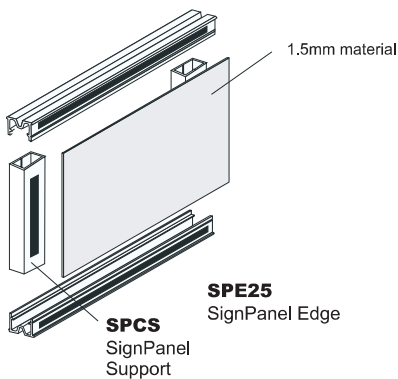

SPE25
SignPanel Edge

SPCS
SignPanel
Support

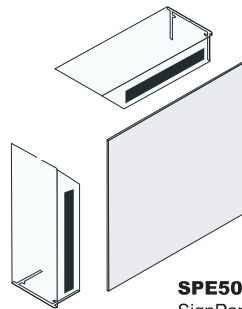

SPE50
SignPanel Edge
(for flush face system)

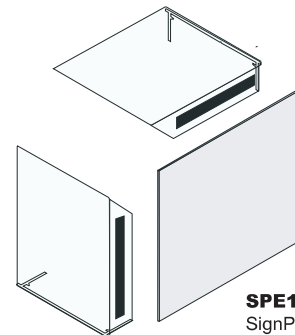

SPE100
SignPanel Edge
(for flush face system)

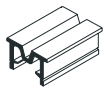

SPE25
SignPanel Edge



SPCS
SignPanel Centre
Support

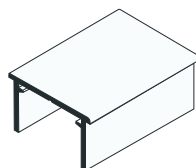

SPE50
SignPanel Edge
(for flush face)

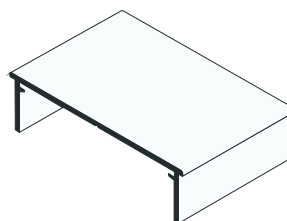

SPE100
SignPanel Edge
(for flush face)

Post Extrusions - 100mm, 75mm and 50mm



SPR100
100mm
Radius Post

SPR50
50mm
Radius Post

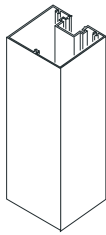

SPS100
100mm
Square Post

SPS50
50mm
Square Post



SPC100*
100mm
Circular Post

SPC75
75mm
Circular Post



SPCT100
100mm
Contour Post

SPCT50
50mm
Contour Post



SPQ100
100mm
Quarter Round

Post Caps - 100mm, 75mm & 50mm



PCR100
Post Cap
Radius

PCR50
Post Cap
Radius

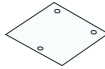

PCS100
Post Cap
Square

PCS50
Post Cap
Square



PCC100
Post Cap
Circular

PCC75
Post Cap
Circular



PCCT100
Post Cap
Contour

PCCT50
Post Cap
Contour

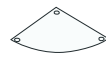

PCQ100
Post Cap
Quarter Round

Post Assembly Components



SPF100
Sign Post
Filler



SPFC100
Sign Post Filler
Circular

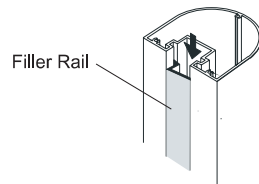

40mm Wall Channel Extrusion and Caps

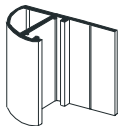

WCR
Wall Channel
Radius



WCS
Wall Channel
Square



WCC-R
Wall Channel
Cap - Radius



WCC-S
Wall Channel
Cap - Square

Miscellaneous Components



PCF
Post Cap
Screw for all post &
wall channel caps



SBRP
Roll Pin