

arcadia®



Simple.Elegant.Functional

Arcadia offers functional design, from a single module to a comprehensive system. Its unique patent pending Contour profiles and decorative design truly sets Arcadia apart from the rest.

Your Source for Sign Systems



SPECIFICATION GUIDE

Series 1000

Arcadia Vertical

Arcadia Series 1000 features an extruded aluminium base, designed to hold a variety of modular insert components, including laser printed paper, injected moulded message strips, braille and tactile plaques and more.

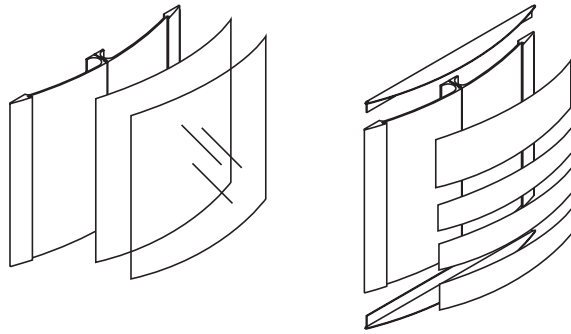

Series 2000

Arcadia Horizontal

Utilizing the same simple components as Series 1000, Arcadia's Series 2000 features an entirely different look. With Contour edge profiles at top and bottom, Series 2000 offers a new range of creative solutions.

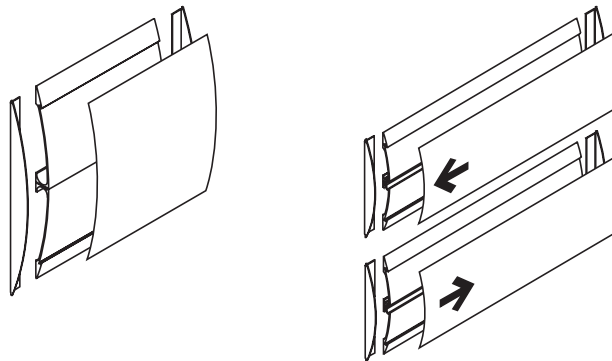

Series 3000

Arcadia Free Standing

Free standing signs allow for placement in open areas, as well as easy relocation of temporary signs, and Arcadia's Series 3000 offers one of the most well designed yet simple and easy solutions available.

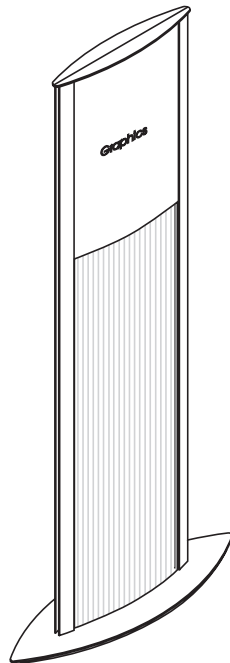

ARFS-430
430mm Width

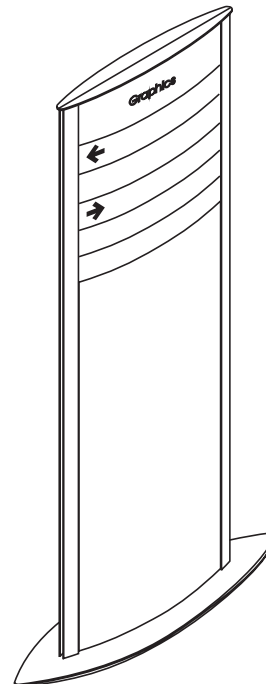

ARFS-560
560mm Width

Holders

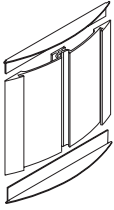

ARH100
100mm Width

ARH100 Holder Specifications

Overall Width: 128.6mm
 Visual Width: 95.25mm
 Insert Width: 100mm - 103.2mm
 Max. Insert Thickness: 2.2mm

Notes:

1. Maximum insert thickness may vary slightly depending upon the finish of the sign holders, i.e silver anodised, wet-sprayed etc.

Finishes - Silver Anodised

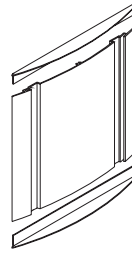

ARH150
150mm Width

ARH150 Holder Specifications

Overall Width: 190.5mm
 Visual Width: 147.62mm
 Insert Width: 152.5mm - 155.58mm
 Max. Insert Thickness: 2.2mm

Notes:

1. Maximum insert thickness may vary slightly depending upon the finish of the sign holder, i.e. Silver anodised, wet-sprayed etc.

Finishes - Silver Anodised

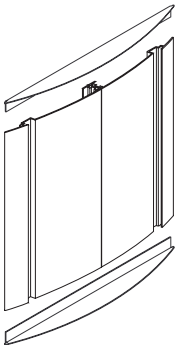

ARH215
215mm Width

ARH215 Holder Specifications

Overall Width: 257.78mm
 Visual Width: 206.38mm
 Insert Width: 212.3mm - 215.9mm
 Max. Insert Thickness: 2.2mm

Notes:

1. Maximum insert thickness may vary slightly depending upon the finish of the sign holders, i/e. Silver anodised, wet sprayed etc.

Finishes - Silver Anodised

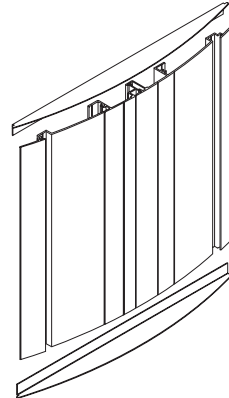

ARH280-L / R
280mm Width

ARH280 Holder Specifications

Overall Width: 330.2mm
 Visual Width: 268.3mm
 Insert Width: 276.2mm - 281mm
 Max. Insert Thickness: 2.4mm

Notes:

1. Maximum insert thickness may vary slightly depending upon the finish of the sign holders, i.e. Silver anodised, wet sprayed etc.

Finishes - Silver Anodised

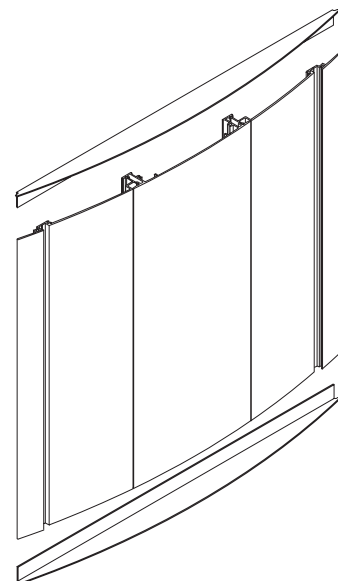

ARH430-L / R
ARH430-C
430mm Width

ARH430 Holder Specifications

Overall Width: 477mm
 Visual Width: 415.93mm
 Insert Width: 427mm - 432.6mm
 Max. Insert Thickness: 2.4mm

Notes:

1. Maximum insert thickness may vary slightly depending upon the finish of the sign holders, i.e silver anodised, wet sprayed etc.

Finishes - Silver Anodised

Aluminium Caps

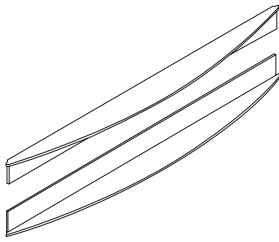

Product Code	Description	Attachment to Holder Via
AR100ECM	Caps for ARH100	12mm x 0.8mm Vinyl Tape
AR150ECM	Caps for ARH150	"
AR215ECM	Caps for ARH215	"
AR280ECM	Caps for ARH280	Rivets and 12mm x 0.8mm Vinyl Tape
AR430ECM	Caps for ARH430	"

Standard Finish - Silver Anodised

Mounting Options

From walls to ceiling to desk tops, and office panel systems, Arcadia offers a range of quality, well-engineered attachment solutions for every environment and situation.

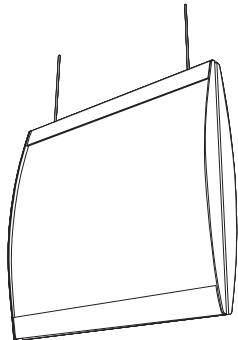

ARSCM
Suspended Ceiling

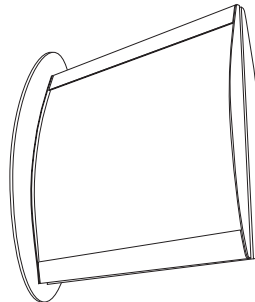

ARPWM2000
Projecting Wall Series 2000

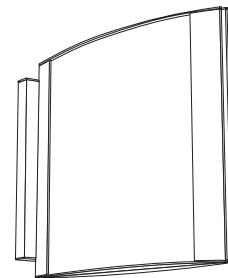

ARPWM1000
Projecting Wall Series 1000

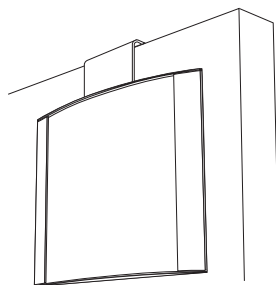

ARPCA
Aluminium Clip Attachment

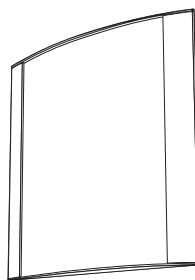

ARST
Wall Mount
Vinyl Tape and/or
Mechanical Fasteners

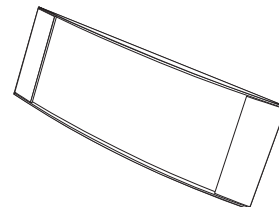

ARDSA
Desk Top